

# JVC



## Powered Subwoofer

Subwoofer motriz

Subwoofer energizado

大功率副低音扬声器

سماعة ويفر فرعية تشغيل آلي

# SP-DW103

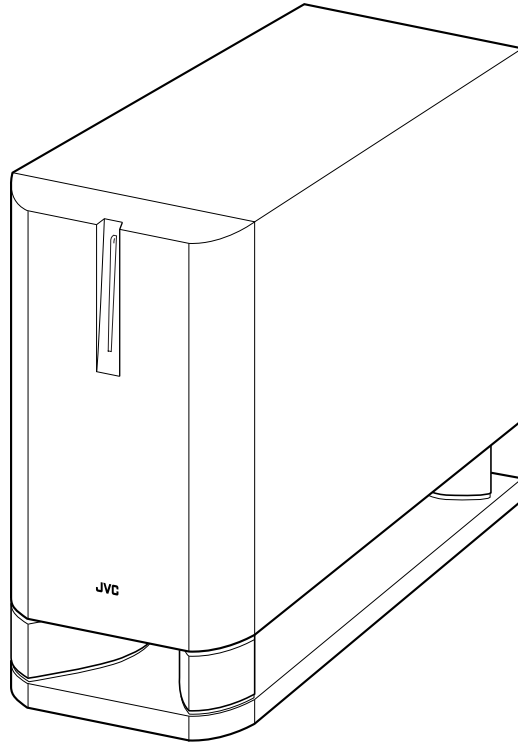

## INSTRUCTIONS

MANUAL DE INSTRUCCIONES

INSTRUÇÕES

使用说明书

دليل التعليمات

### For Customer Use:

Enter below the Model No. and Serial No. which are located either on the rear, bottom or side of the cabinet. Retain this information for future reference.

Model No. \_\_\_\_\_

Serial No. \_\_\_\_\_

LVT1030-002C  
[US/UJ/UW/UG]

Thank you for purchasing a JVC speaker.

Before you begin using it, please read the instructions carefully to be sure you get the best possible performance. If you have any questions, consult your JVC dealer.

## Warnings, Cautions and Others

To reduce the risk of electrical shocks, fire, etc.:

1. Do not remove screws, covers or cabinet.
2. Do not expose this appliance to rain or moisture.

### Caution—POWER switch

This apparatus is provided with the POWER switch to minimize power consumption for safe use. Therefore,

1. Before doing initial settings, complete all the connections required, connect the mains plug into the wall outlet, then set the POWER switch to ON [ I ].
2. When not in use, set the POWER switch to OFF [ O ]. This disconnects the mains line.

### Cautions

- Do not block the ventilation openings or holes. (If the ventilation openings or holes are blocked by a newspaper or cloth, etc., the heat may not be able to get out.)
- Do not place any naked flame sources, such as lighted candles, on the apparatus.
- When discarding batteries, environmental problems must be considered and local rules or laws governing the disposal of these batteries must be followed strictly.
- Do not expose this apparatus to rain, moisture, dripping or splashing and that no objects filled with liquids, such as vases, shall be placed on the apparatus.

### Caution—Proper Ventilation

To avoid risk of electric shock and fire, and to prevent damage, locate the apparatus as follows:

- 1 Front: No obstructions and open spacing.
- 2 Sides/ Top/ Back: No obstructions should be placed in the areas shown by the dimensions below.
- 3 Bottom: Place on the level surface. Maintain an adequate air path for ventilation by placing on a stand with a height of 10 cm or more.

Front view

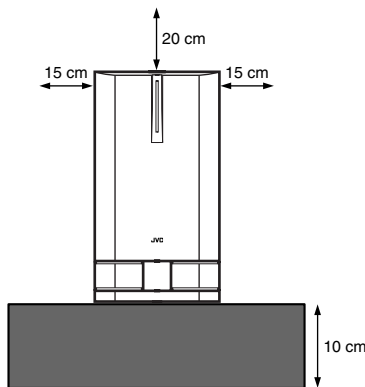

Side view

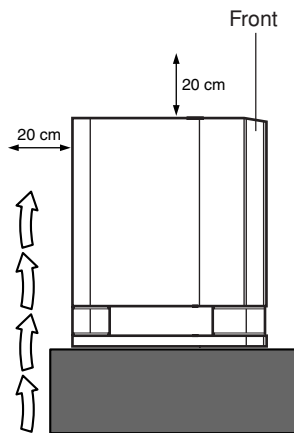

## Precautions for installation

- To prevent deformation or discoloration of the cabinet, do not install the unit where it is exposed to direct sunlight or high humidity, and avoid installation near air conditioning outlets.



- Speaker vibrations may cause howling. Place the unit as far away from the player as possible.



- Take the occurrence of earthquakes or other physical shocks into consideration when selecting the installation place, and secure the unit thoroughly.



- This unit is magnetically shielded to avoid color distortions on TVs. However, if not installed properly, it may cause color distortions. So, pay attention to the following when installing the unit.
  - When placing this unit near a TV set, turn off the TV's main power switch or unplug it before installing this unit. Then wait at least 30 minutes before turning on the TV's main power switch again. Some TVs may still be affected even though you have followed the above. If this happens, move this unit away from the TV.
- Tuner reception may become noisy or hissing if this unit is installed nearby the tuner. In this case, leave a more distance between the tuner and this unit or use an outdoor antenna for better tuner reception without interference from this unit.

## Precautions for Daily Use

### To maintain the appearance of the unit

Wipe with a dry, soft cloth if the cabinet or control panel should become dirty.

If very dirty, apply a small amount of water or neutral detergent to the cloth and wipe clean. Then wipe with a dry cloth.

### To improve the sound field

If the speakers are facing a solid wall or glass door, etc., it is recommended to furnish the wall with materials that absorb sounds, for example by hanging up thick curtains, to prevent reflections and standing waves.



## Checking the Supplied Accessories

Check to be sure you have the following supplied accessories. The number in parenthesis indicates the quantity of the piece supplied.

- Monaural audio cord (1)
- AC plug adaptor (1)

If the item mentioned above is missing, contact your dealer immediately.

## English

### Contents

<b>Connections</b> .....	1
Checking Your Amplifier .....	1
Connecting to the Amplifier .....	1
<b>Operations</b> .....	3
<b>Additional Information</b> .....	5

## Español

### Contenido

<b>Conexiones</b> .....	1
Verificación de su amplificador .....	1
Conexión al amplificador .....	1
<b>Operaciones</b> .....	3
<b>Información adicional</b> .....	5

## Português

### Índice

<b>Conexões</b> .....	1
Para Verificar o Amplificador .....	1
Para Conectar ao Amplificador .....	1
<b>Operações</b> .....	3
<b>Informações Adicionais</b> .....	5

## 中文

### 目录

连接 .....	1
检查您的扩音器 .....	1
连接至扩音器 .....	1
操作 .....	3
附加信息 .....	5

## عربي

### المحتويات

١ .....	التوصيلات
١ .....	فحص مضخم الصوت
١ .....	التوصيل مع مضخم الصوت
٣ .....	التشغيلات
٥ .....	المعلومات الاضافية

The printed pattern of the rear panel may differs according to the countries of purchase.

El panel impreso en el panel trasero puede diferir según el país de compra.

A etiqueta impressa no painel traseiro poderá ser diferente dependendo do país em que o equipamento for adquirido.

后面板的印刷图案会因购买国家不同而有所分别。

يمكن ان يختلف النموذج المطبوع على اللوحة الخلفية وذلك حسب الاقطار التي تشتري هذا الجهاز.

## Connections

### Checking Your Amplifier

Before connecting this unit to your amplifier (or receiver), check what types of connecting terminals your amplifier has.

Follow the instructions below to find a proper connection method for your equipment.

- Illustrations of jacks and terminals in this manual may be different from the ones actually used for your amplifier. The illustrations are of the most used type.

#### First check whether your amplifier has a subwoofer output jack.

It is usually named and printed as the "SUBWOOFER OUT" or "SUBWOOFER."

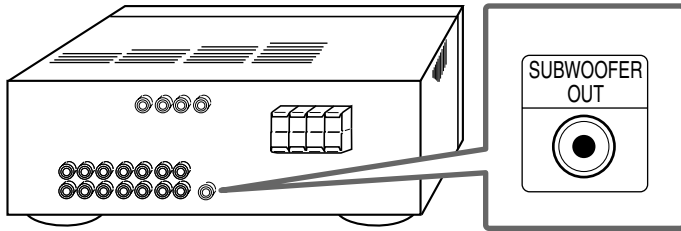

If you find it on your amplifier, follow **Connecting Method A**.

If you cannot find any

#### Next check whether your amplifier has line output jacks.

They are usually named and printed as "LINE OUT" or "LINE OUTPUT."

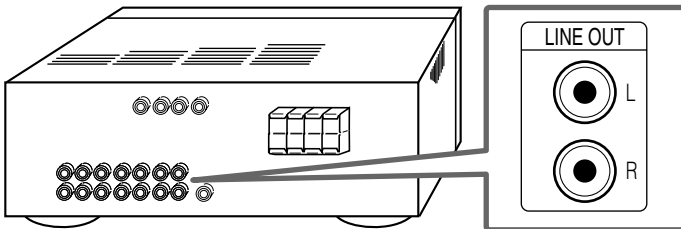

If you find them on your amplifier, follow **Connecting Method B**.

If you cannot find any

#### Follow **Connecting Method C**.

This connection can be used for any amplifier, by connecting the front speaker terminals of the amplifier (usually named and printed as "FRONT SPEAKERS" or "MAIN SPEAKERS").

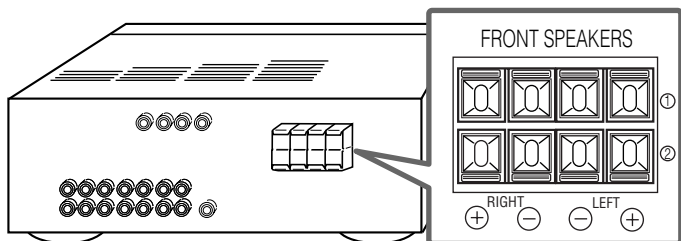

### CAUTION

Before connecting this unit to the amplifier (or receiver), observe the following carefully.

- Before connecting this unit to an amplifier, turn off the amplifier first.
- Make all connections before plugging in this unit.
- DO NOT use the INPUT 1 (LOW-LEVEL) and INPUT 2 (HIGH-LEVEL) terminals on the rear of this unit at the same time; otherwise, noise will be heard and may damage the unit.
- DO NOT connect this unit to the REC OUT jacks of your amplifier.

### Connecting to the Amplifier

When connecting to your amplifier (or receiver), refer also the manual supplied for your equipment.

#### ■ Connecting Method A

Connect an amplifier having a subwoofer output jack to the LEFT/MONO jack of the INPUT 1 (LOW-LEVEL) terminal.

#### Preparation:

Use the supplied monaural audio cord.

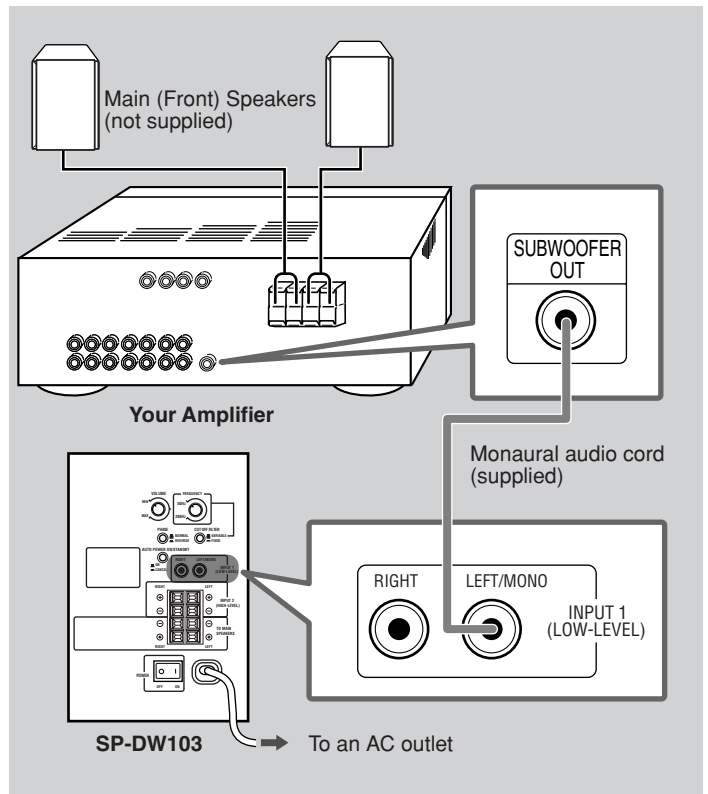

### MEMO

When using **Connecting Method A**, no signal comes out of the TO MAIN SPEAKERS terminal.

### ■ Connecting Method B

Connect an amplifier having line output jacks to the INPUT 1 (LOW-LEVEL) terminal.

#### Preparation:

Purchase a stereo audio cord at an audio shop or electric shop.

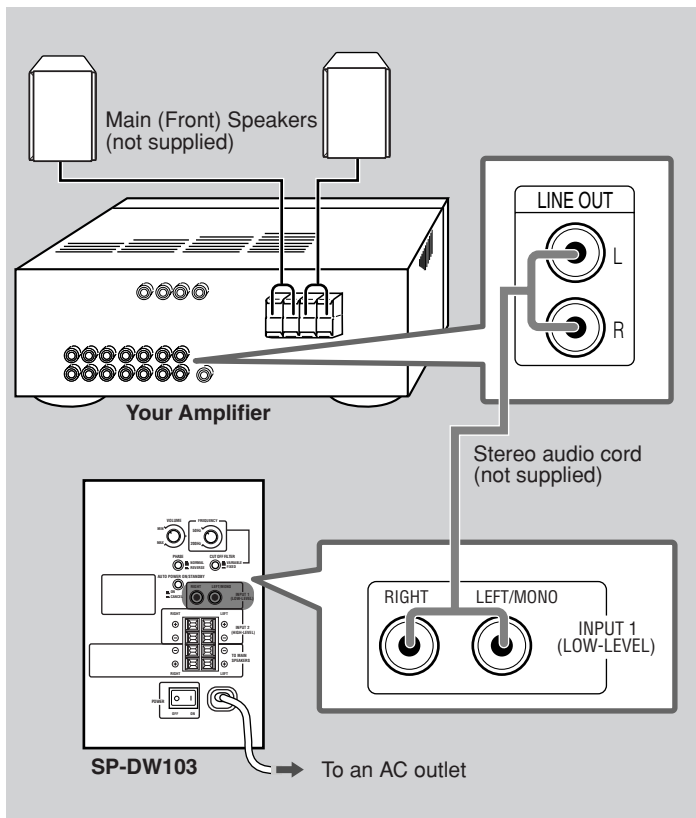
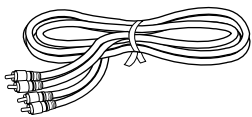

### MEMO

If your amplifier has only a monaural line output (MONO) jack, connect it to the LEFT/MONO jack of the INPUT 1 (LOW-LEVEL) terminal (see **Connecting Method A**).

### ■ Connecting Method C

Connect an amplifier without a subwoofer output jack and line output jacks to the INPUT 2 (HIGH-LEVEL) terminal.

- When this method is used, connect your main (front) speakers to the TO MAIN SPEAKERS terminal on the rear of this unit.

#### Preparation:

Purchase speaker cords at an audio shop or electric shop.

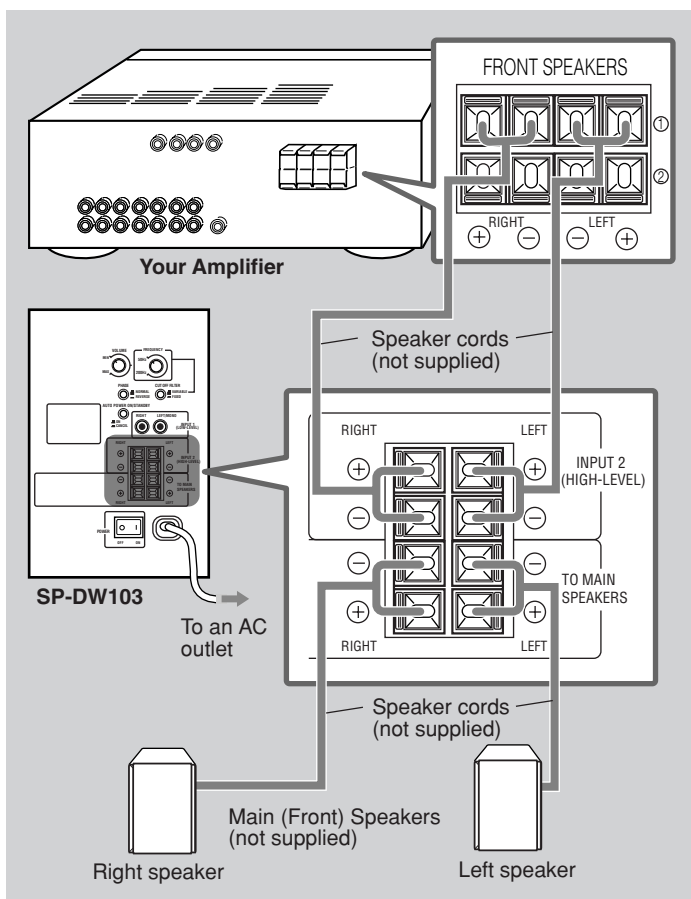

#### How to connect the speaker cords:

- 1 Press and hold the clamp of the speaker terminal.
- 2 Insert the end of the speaker cord into the terminal as illustrated below.
  - Match the polarity of the speaker terminals: ⊕ to ⊕ and ⊖ to ⊖.
- 3 Release the finger from the clamp.

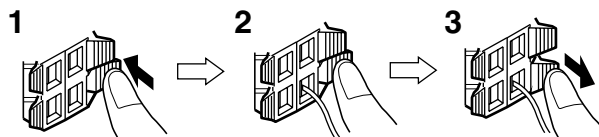

### CAUTION

- When you connect main (front) speakers to the TO MAIN SPEAKERS terminal, use the speakers within the impedance range indicated by the amplifier connected to the INPUT 2 (HIGH-LEVEL) terminal. If not, the amplifier connected to the INPUT 2 (HIGH-LEVEL) terminal may malfunction and be damaged.
- DO NOT connect more than one speaker to one speaker terminal.

# Operations

Front view

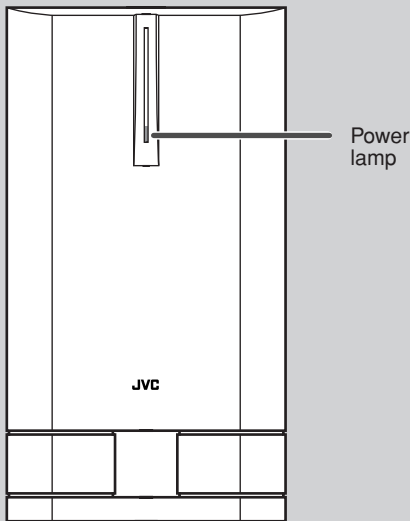

Rear view

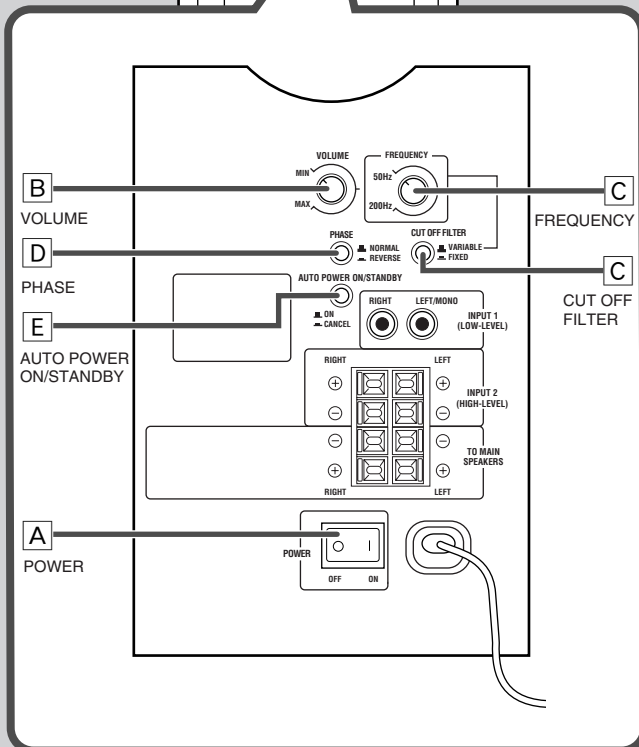
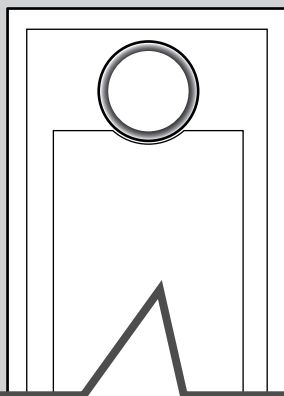

The unit automatically accommodates AC power between 110V and 240V. You do not need any setting to match the unit with your local power voltage.

## Turning On the Power—POWER [A]

Press the ON [ I ] portion of the POWER switch.

The main power turns on and the power lamp in the front panel lights in green.

- The power lamp lights in red when the Auto Power On/Standby places the unit into standby mode (see page 4).

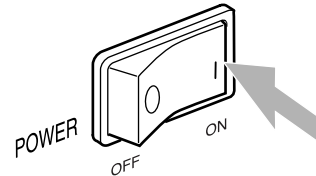

## To completely cut off the power to this unit

Press the OFF [ O ] portion of the POWER switch. This will disconnect the mains lead.

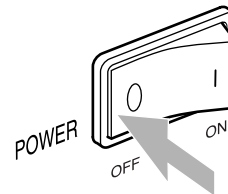

## Adjusting the Volume—VOLUME [B]

Adjust the volume output level through this unit while comparing with the sounds coming out of the main (front) speakers.

- Once you have adjusted the volume output level of this unit, you do not need to adjust it each time you use this unit. Adjusting the volume level on the connected amplifier will also adjust the volume level through this unit.

### 1 Turn the VOLUME knob to the MIN position.

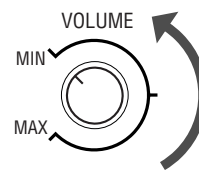

### 2 Turn on the connected amplifier and start playing a source.

Playback sounds come out of the main (front) speakers and this unit.

### 3 Adjust the VOLUME knob to obtain a well-balanced sound level with that of the main (front) speakers.

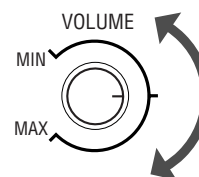

## CAUTION

If the volume is set at a high level before starting play, the sudden blast of sound energy can permanently damage your hearing and/or ruin your speakers.

## Adjusting the Crossover Frequency

### —CUT OFF FILTER and FREQUENCY [C]

You can adjust the crossover frequency to determine the bass sound level this unit handles.

- Once it is set, only the sounds below the frequency come out of the built-in speaker.

### ■ When the main speakers in use are JVC's SP-X103, SP-F303 or SX-XD33

Press in the CUT OFF FILTER button to set it to the **■ FIX** position.



- The FREQUENCY knob is deactivated.
- When your amplifier is equipped with crossover frequency setting, set it within the range of 100 Hz to 150 Hz.
- When your amplifier is equipped with speaker size setting, select "small."

### ■ If your amplifier is not provided with a crossover frequency setting:

#### 1 Press out the CUT OFF FILTER button to set it to the **■ VARIABLE** position.

Now the FREQUENCY knob is activated and you can adjust the crossover frequency on this unit.



#### 2 Turn the FREQUENCY knob to obtain the best matching crossover frequency with your main speakers.

Adjust the frequency (50 Hz to 200 Hz) while listening to playback sound coming out of both the main speakers and this unit.

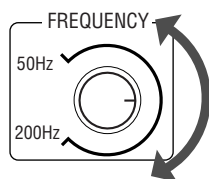

- If your main speakers can reproduce the bass sound well, adjust the frequency at a lower level.
- If you feel bass sounds are not sufficient, adjust the frequency at a higher level.

## Changing the Phase—PHASE [D]

You can change the sound phase to match your preference. Select either "NORMAL" or "REVERSE" to obtain a better bass sound.

Press in or out the PHASE button to select either the NORMAL position or the REVERSE position.



- NORMAL : Normally select this.
- REVERSE : Select this when you feel the bass sound is better with this mode rather than with "NORMAL."

## Operating the Unit Automatically According to the Incoming Signals—AUTO POWER ON/STANDBY [E]

By using this function, this unit automatically enters standby mode even though the POWER switch is turned ON [I].

Press the AUTO POWER ON/STANDBY button to the **■ ON** position.

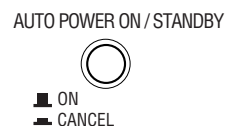

- If no sound comes in for about 10 minutes, the unit automatically enters standby mode. The power lamp lights in red. Then if the unit detects incoming signals, this unit starts operating automatically (the power lamp now lights in green).

If Auto Power On/Standby does not work correctly (see "MEMO" below), press out the AUTO POWER ON/STANDBY button to set it to the **■ CANCEL** position. Auto Power On/Standby is canceled.

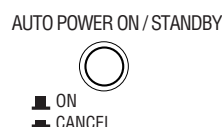

When the volume level of the amplifier is so low or the incoming signals are so weak that this unit cannot detect sounds, Auto Power On/Standby may not work correctly.

- This unit may enter standby mode even though signals are coming in.
- This unit may not start operating after entering standby mode, even though signals start coming in.

## Additional Information

### Speaker layout

To obtain the best possible sound from your unit:

- Place a subwoofer wherever you like since bass sound is non-directional. Normally place it in front of you.
- Place all the main speakers at the same distance from the listening position.

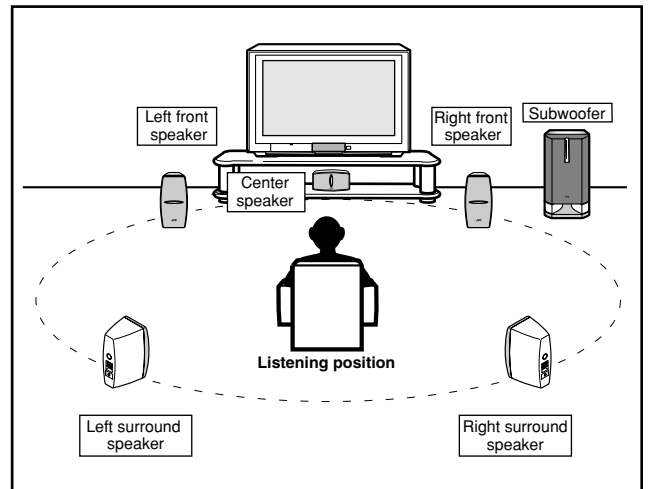

### Troubleshooting

Use this chart to help you solve daily operational problems. If there is any problem you cannot solve, contact your dealer.

Symptom	Possible Cause	Action
Power does not come on.	Is the unit plugged in?	Plug the AC power cord firmly into the AC outlet.
Auto Power On/Standby does not function correctly.	Signals are too weak or volume level is too low.	This is not a malfunction. If this happens, cancel Auto Power On/Standby.
No sound is heard.	Is the VOLUME knob turned to the MIN position?	Turn the VOLUME knob until a suitable volume is found.
	Connections are incorrect, or loose.	Check the connections. If incorrect, redo the corrections. (See pages 1 and 2.)
	Audio signals through the amplifier are extremely weak.	Increase the volume level on the amplifier.
Sounds fluctuate (suddenly become loud or soft).	The built-in protective circuit is working.	Lower the volume level on the amplifier so that the symptom will not occur.
Suddenly no sound comes out. —the power lamp lights in red.	The VOLUME knob on the rear is set to a very high level.	Turn down the volume, then turn off and on this unit.
Suddenly no sound comes out. —the power lamp still lights in green.	The volume of the playback source is too high.	Turn down the volume of the playback source, turn off and on the source, then adjust the volume properly on the source.

### Specifications

<b>Type :</b>	Powered Subwoofer Bass-reflex type, (magnetically shielded type)
<b>Speaker unit :</b>	16.0 cm cone (× 1)
<b>Frequency range :</b>	30 Hz to 200 Hz
<b>Input impedance :</b>	50 kΩ (LOW-LEVEL) 470 Ω (HIGH-LEVEL)
<b>Input terminals :</b>	INPUT 1 (LOW-LEVEL) INPUT 2 (HIGH-LEVEL)
<b>Power requirements :</b>	AC 110 V–240 V $\sim$ , 50 Hz/60 Hz
<b>Output power of built-in amp :</b>	100 W (45 Hz, 4 Ω, 10 % THD)
<b>Power consumption :</b>	27 W
<b>Dimensions :</b>	210 mm (width) × 392 mm (height) × 348 mm (depth)
<b>Mass :</b>	10 kg
<b>Accessories :</b>	Monaural audio cord (× 1) AC plug adaptor (× 1)





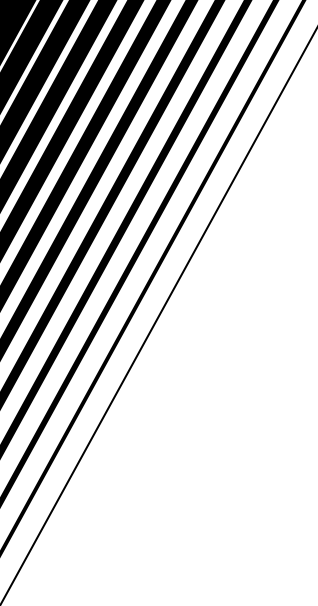

**JVC**  
VICTOR COMPANY OF JAPAN, LIMITED